



## Product Range Information

POD is a range of 'print on demand' presentation products that can be easily branded by inserting printed paper sheets to produce professional looking personalised materials quickly and easily.

POD is ideal for:

- \*Business events
- \*Exhibitions
- \*Promotions
- \*Marketing activities
- \*Document storage

This document contains information on each product in the range and should be used as a resource to assist when ordering POD items and generating artwork for the printed inserts.

Note: all transit carton dimensions and label positions are as indicated:

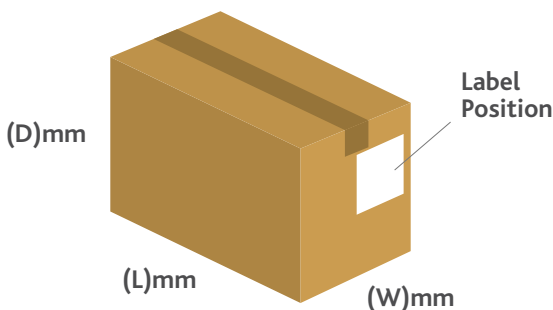

For stock identification each product is discretely printed with a reference code and the generic POD identity. In addition a location has been included for the application of a 12mm printed sticker. This enables resellers to add their own brand to the products if required.

For further information on the range including images, movies and downloadable templates please go to

[www.ThePodRange.co.uk](http://www.ThePodRange.co.uk)

## Contents

Bottle Gift Bag.....	3
Large Boutique Bag.....	4
Small Boutique Bag.....	5
X Small Boutique Bag.....	6
Tuff A4 Binder.....	7
X File Binder.....	8
A4 4 Ring Binder 11mm.....	9
A4 4 Ring Binder 25mm.....	10
A4 2 Ring Binder 40mm.....	11
A5 2 Ring Binder 35mm.....	12
A4 Binding Covers.....	13
A4 Flat Folder.....	14
A4 Landscape Folder.....	15
A4 File Box 20mm.....	16
A4 File Box 40mm.....	17
Magazine File.....	18
Mouse Mat.....	19
A3 Mat.....	20
Travel Card Wallet.....	21
Name Plate Display.....	22
A5 Leaflet Dispenser.....	23
30cm Ruler.....	24
Square Coaster.....	25
A4 Display Unit.....	26
A3 Display Unit.....	27
Totem 660mm.....	28
Totem 900mm.....	29
Totem 1200mm.....	30
Totem 1600mm.....	31
Movie Presentation Folder.....	32
Sample Set.....	33
Sample Set & Display.....	34

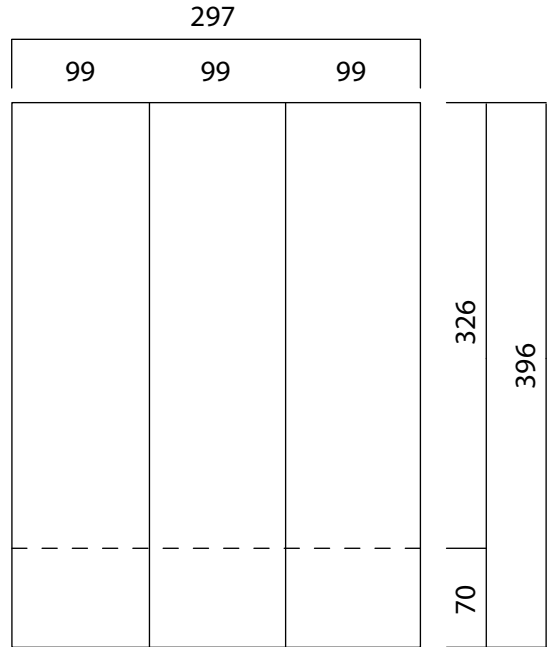

## Bottle Gift Bag

POD-BBW

Description	<b>Frosted plastic bag with white rope handles</b>
Size	<b>100(W) x 350(H) x 100(D)mm</b>
Material	<b>180mic Frosted PP</b> 
Product Design	<b>D****</b>

## INSERT SHEET

Trimmed Size	<b>99 x 396mm</b>
Number out	<b>3 out (A3)</b>

## PACKAGING DETAILS

Outer Case Design No.	<b>D6706</b>	Internal Dimensions (L x W x D)	<b>533(L) X 426(W) X 100(D)mm</b>
Style	<b>0201 GLUED</b>	External Dimensions	<b>549(L) x 442(W) x 132(D)mm</b>
Material	<b>150KT BC FLUTE</b>	Case Weight	<b>4.6 Kg</b>
Unit QTY Per Box	<b>100</b>		

## LABEL



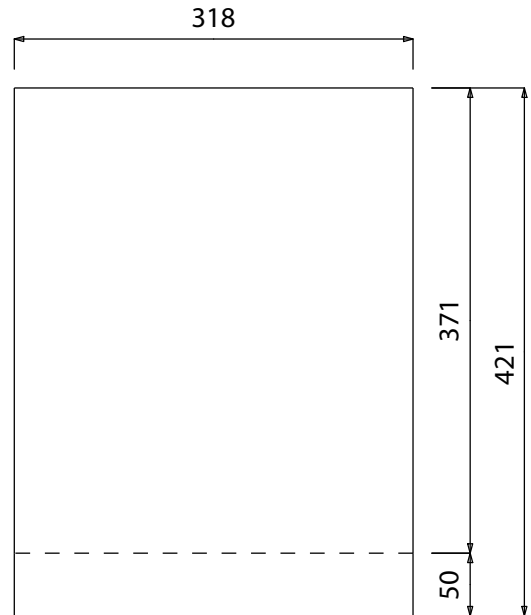

## Large Boutique Bag

POD-BBL

### Description

Frosted plastic bag with white rope handles

### Size

320(W) x 400(H) x 130(D)mm

### Material

180mic Polypropylene



### Product Design

D\*\*\*\*

## INSERT SHEET

### Trimmed Size

421 x 318mm

### Number out

1 (SRA3)

## PACKAGING DETAILS

### Outer Case Design No.

D6707

### Internal Dimensions (L x W x D)

490(L) x 326(W) x 140(D)mm

### Style

0201 GLUED

### External Dimensions

506(L) x 342(W) x 172(D)mm

### Material

150KT BC FLUTE

### Case Weight

8 Kg

### Unit QTY Per Box

50

## LABEL



Large Boutique Bag

POD-BBL

QTY

50

8Kg

MADE IN EU

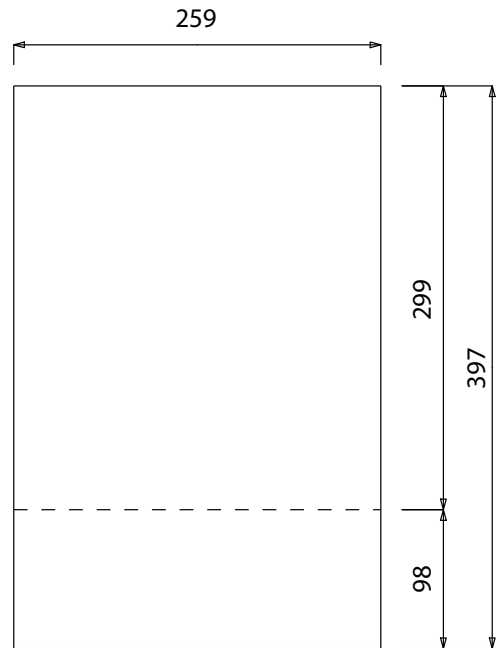

## Small Boutique Bag

POD-BBS

### Description

Frosted plastic bag with white rope handles

### Size

260(W) x 323 (H) x 100(D)mm

### Material

180mic Polypropylene



### Product Design

D\*\*\*\*

## INSERT SHEET

### Trimmed Size

397 x 259mm

### Number out

1 (A3)

## PACKAGING DETAILS

### Outer Case Design No.

D5144

### Internal Dimensions (L x W x D)

425(L) x 275(W) x 155(D)mm

### Style

0201 GLUED

### External Dimensions

441(L) x 291(W) x 187(D)mm

### Material

150KT BC FLUTE

### Case Weight

4.1 Kg

### Unit QTY Per Box

50

## LABEL



Small Boutique Bag

POD-BBS

QTY

50

4.1Kg

MADE IN EU

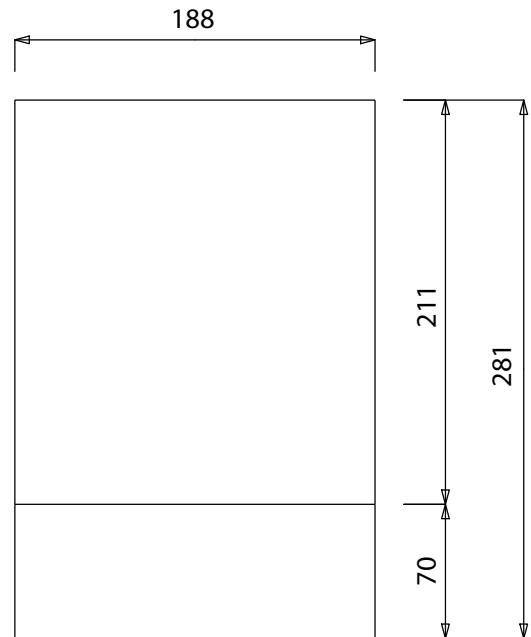

## X Small Boutique Bag

POD-BBXS

Description	<b>Frosted plastic bag with white rope handles</b>
Size	<b>190 (W) x 236 (H) x 70 (D)mm</b>
Material	<b>180mic Polypropylene</b> 
Product Design	<b>D****</b>

## INSERT SHEET

Trimmed Size	<b>281 x 188mm</b>
Number out	<b>1 (A4)</b>

## PACKAGING DETAILS

Outer Case Design No. <b>D6708</b>	Internal Dimensions (L x W x D) <b>382(L) x 280(W) x 100(D) mm</b>
Style <b>0201 GLUED</b>	External Dimensions <b>398(L) x 296(W) x 132(D) mm</b>
Material <b>150KT BC FLUTE</b>	Case Weight <b>2.7 Kg</b>
Unit QTY Per Box <b>50</b>	

## LABEL



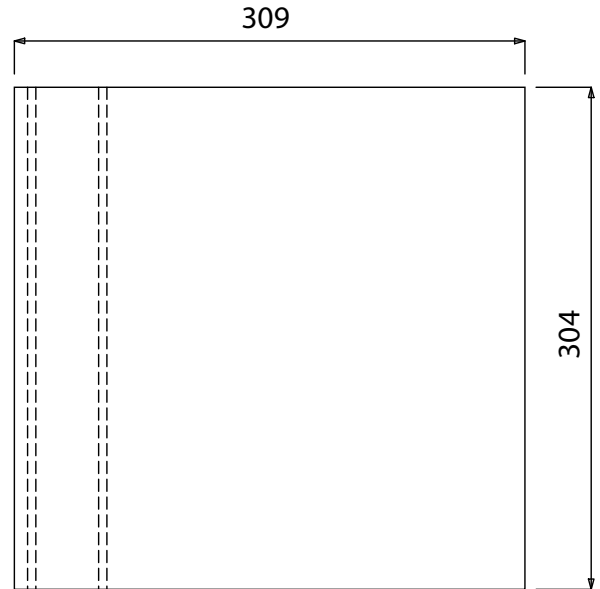

## Tuff A4 Binder

POD-A4TFPB

### Description

Frosted plastic bag with white rope handles

### Size

259 (W) x 318 (H) x 38 (D)mm

### Material

88% Recycled PP



### Product Design

D5220

## INSERT SHEET

### Trimmed Size

309 x 304mm

### Number out

1 (SRA3)

## PACKAGING DETAILS

### Outer Case Design No.

D6710

### Internal Dimensions (L x W x D)

455 (L) x 325 (W) x 322 (D)mm

### Style

0201 GLUED

### External Dimensions

471 (L) x 341 (W) x 354 (D)mm

### Material

150KT BC FLUTE

### Case Weight

11 Kg

### Unit QTY Per Box

25

## LABEL



Tuff A4 Binder

POD-A4TFPB

QTY

25

11Kg

MADE IN EU

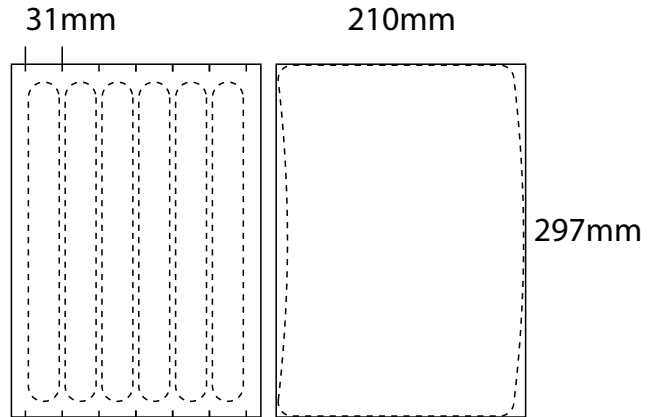

## X File Binder

POD-XF4W

Description	4D ring 25mm capacity
Size	295 (W) x 330 (H) x 40 (D) mm
Material	White PP 
Product Design	D6585

## INSERT SHEET

Trimmed Size	297 x 210mm (Cover) / 31 x 297mm (Spine)
Number out	1 cover (A4) / 6 spines (A4)

## PACKAGING DETAILS

Outer Case Design No.	D6709	Internal Dimensions (L x W x D)	550 (L) x 305 (W) x 340 (D) mm
Style	0201 GLUED	External Dimensions	566 (L) x 321 (W) x 372 (D) mm
Material	150KT BC FLUTE	Case Weight	11.7 Kg
Unit QTY Per Box	20		

## LABEL





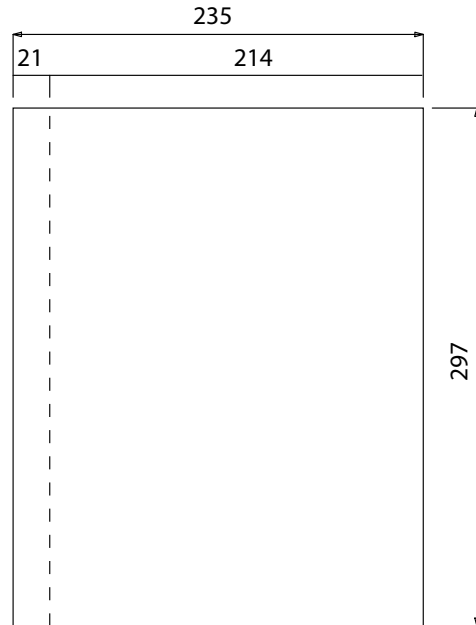

## A4 4 Ring Binder 11mm

POD-A4B11

### Description

4D ring 11mm capacity

### Size

240 (W) x 309 (H) x 22 (D) mm

### Material

800mic Ice PP



### Product Design

D4351

## INSERT SHEET

### Trimmed Size

235 x 297mm

### Number out

1 (A3)

## PACKAGING DETAILS

### Outer Case Design No.

D6722

### Style

0201 GLUED

### Material

150KT BC FLUTE

### Unit QTY Per Box

50

### Internal Dimensions (L x W x D)

338 (L) x 260 (W) x 315 (D) mm

### External Dimensions

354 (L) x 276 (W) x 347 (D) mm

### Case Weight

8.5 Kg

## LABEL



A4 4 Ring Binder

POD-A4B11

QTY

50

8.5Kg

MADE IN EU

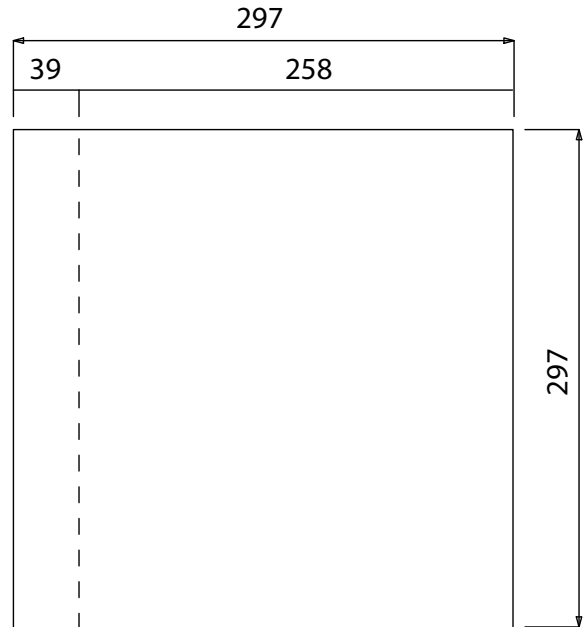

## A4 4 Ring Binder 25mm

POD-A4B25

### Description

4D ring 25mm capacity

### Size

262 (W) x 309 (H) x 40 (D) mm

### Material

800mic Ice PP



### Product Design

D5344

## INSERT SHEET

### Trimmed Size

297 x 297mm

### Number out

1 (A3)

## PACKAGING DETAILS

### Outer Case Design No.

D6722

### Style

0201 GLUED

### Material

150KT BC FLUTE

### Unit QTY Per Box

25

### Internal Dimensions (L x W x D)

338 (L) x 260 (W) x 315 (D) mm

### External Dimensions

354 (L) x 276 (W) x 347 (D) mm

### Case Weight

11.2 Kg

## LABEL



A4 4 Ring Binder

POD-A4B25

QTY

25

11.2Kg

MADE IN EU

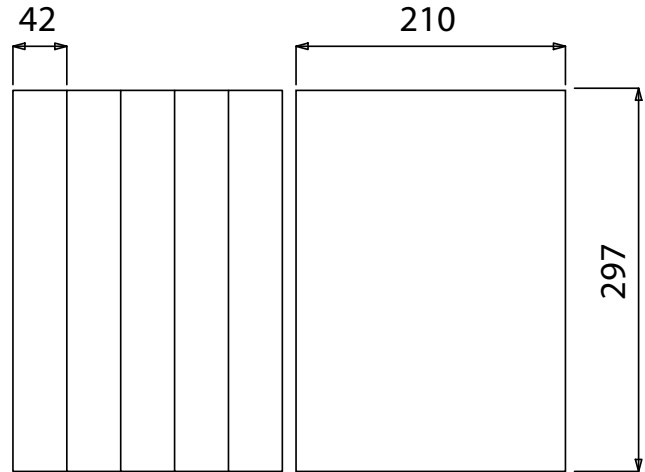

## A4 2 Ring Binder 40mm

POD-2D40A4

Description	2 D ring 40mm capacity
Size	268 (W) x 310 (H) x 50 (D) mm
Material	1200mic Frosted PP 
Product Design	D4391

## INSERT SHEET

Trimmed Size	210 x 297mm (Cover) / 42 x 297mm (Spine)
Number out	1 Cover (A4) / 5 Spines (A4)

## PACKAGING DETAILS

Outer Case Design No. <b>D6721</b>	Internal Dimensions (L x W x D) <b>455 (L) x 325 (W) x 315 (D) mm</b>
Style <b>0201 GLUED</b>	External Dimensions <b>471 (L) x 341 (W) x 347 (D) mm</b>
Material <b>150KT BC FLUTE</b>	Case Weight <b>7 Kg</b>
Unit QTY Per Box <b>25</b>	

## LABEL



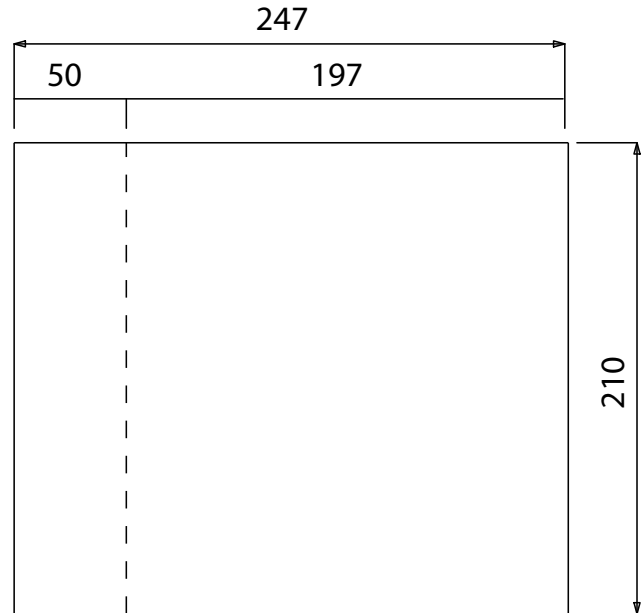

## A5 2 Ring Binder 35mm

POD-A5B35

### Description

2D ring 35mm capacity

### Size

203 (W) x 225 (H) x 51 (D) mm

### Material

800mic Ice PP



### Product Design

D4570

## INSERT SHEET

### Trimmed Size

247 x 210mm

### Number out

1 (A4)

## PACKAGING DETAILS

### Outer Case Design No.

D6710

### Internal Dimensions (L x W x D)

455 (L) x 325 (W) x 322 (D) mm

### Style

0201 GLUED

### External Dimensions

471 (L) x 341 (W) x 354 (D) mm

### Material

150KT BC FLUTE

### Case Weight

7 Kg

### Unit QTY Per Box

50

## LABEL



A5 2 Ring Binder

POD-A5B35

QTY

50

7Kg

MADE IN EU

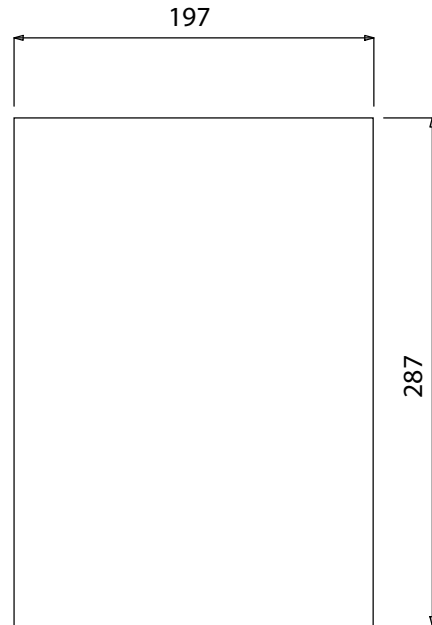

## A4 Binding Covers

POD-A4BC

### Description

Front and back covers for document binding

### Size

297 (L) x 213 (W) x 1 (D) mm

### Material

500mic Ice PP



### Product Design

D6235

## INSERT SHEET

### Trimmed Size

197 x 287mm

### Number out

1 (A4)

## PACKAGING DETAILS

### Outer Case Design No.

D6584

### Internal Dimensions (L x W x D)

300 (L) x 216 (W) x 138 (D) mm

### Style

0201 GLUED

### External Dimensions

316 (L) x 232 (W) x 170 (D) mm

### Material

150KT BC FLUTE

### Case Weight

6.6 Kg

### Unit QTY Per Box

100

## LABEL



A4 Binding Cover

POD-A4BC

QTY

100

6.6Kg

MADE IN EU

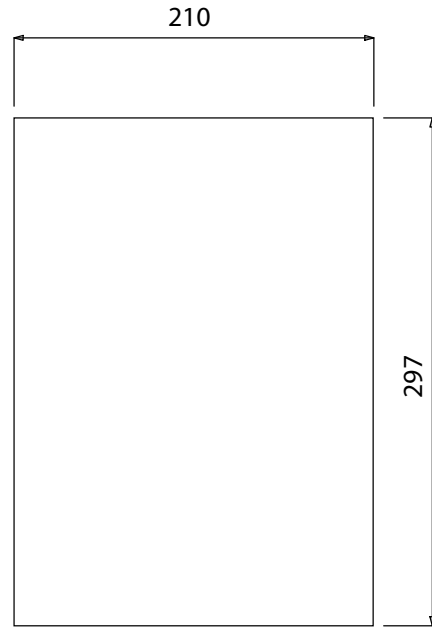

## A4 Flat Folder

POD-A4W0

Description	<b>A4 display pocket to front cover</b>
Size	<b>240(W) x 309(H) x 3(D)mm</b>
Material	<b>500mic Ice PP</b> 
Product Design	<b>D4610</b>

## INSERT SHEET

Trimmed Size	<b>210 x 297mm</b>
Number out	<b>1 (A4)</b>

## PACKAGING DETAILS

Outer Case Design No. <b>D6711</b>	Internal Dimensions (L x W x D) <b>315 (L) x 245 (W) x 130 (D) mm</b>
Style <b>0201 GLUED</b>	External Dimensions <b>331 (L) x 261 (W) x 162 (D) mm</b>
Material <b>150KT BC FLUTE</b>	Case Weight <b>4.7 Kg</b>
Unit QTY Per Box <b>50</b>	

## LABEL



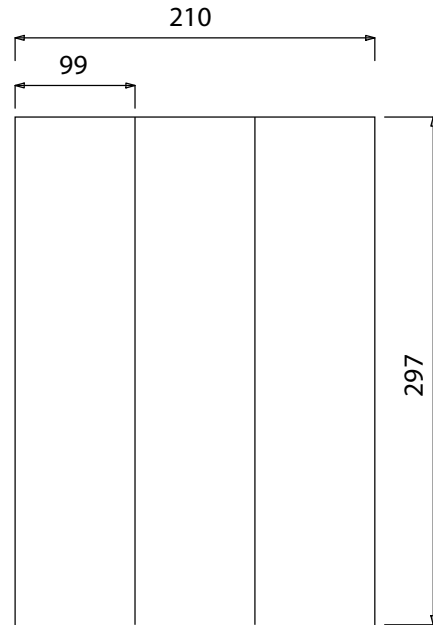

## A4 Landscape Folder

POD-A4FOW

Description	Envelope folder with display area to closing flap	
Size	321 (L) x 240 (W) x 3 (D) mm	
Material	500mic Frosted PP	
Product Design	D4635	

## INSERT SHEET

Trimmed Size	99 x 297mm
Number out	3 (A4)

## PACKAGING DETAILS

Outer Case Design No. <b>D6713</b>	Internal Dimensions (L x W x D) <b>325 (L) x 245 (W) x 260 (D) mm</b>
Style <b>0201 GLUED</b>	External Dimensions <b>341 (L) x 261 (W) x 292 (D) mm</b>
Material <b>150KT BC FLUTE</b>	Case Weight <b>8.6 Kg</b>
Unit QTY Per Box <b>100</b>	

## LABEL



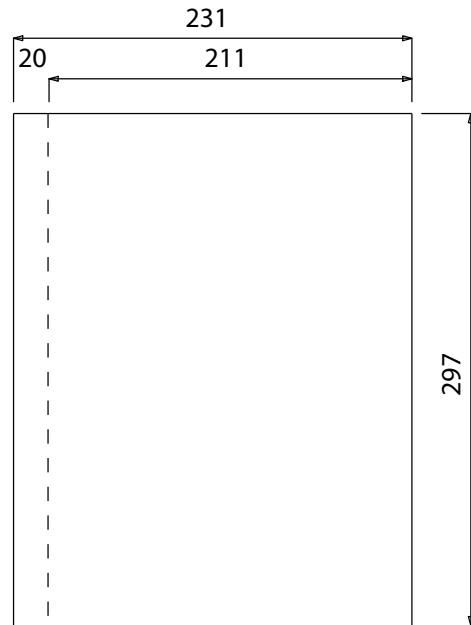

## A4 File Box 20mm

POD-A4W20

### Description

20mm capacity. Display pocket to front and spine

### Size

309 (L) x 240 (W) x 18 (D) mm

### Material

800mic Ice PP



### Product Design

D4352

## INSERT SHEET

### Trimmed Size

231 x 297mm

### Number out

1 (A3)

## PACKAGING DETAILS

### Outer Case Design No.

D5735

### Style

0201 GLUED

### Material

150KT BC FLUTE

### Unit QTY Per Box

50

### Internal Dimensions (L x W x D)

643 (L) x 64 (W) x 473 (D) mm

### External Dimensions

659 (L) x 80 (W) x 489 (D) mm

### Case Weight

8 Kg

## LABEL



A4 File Box 20mm

POD-A4W20

QTY

50

8Kg

MADE IN EU



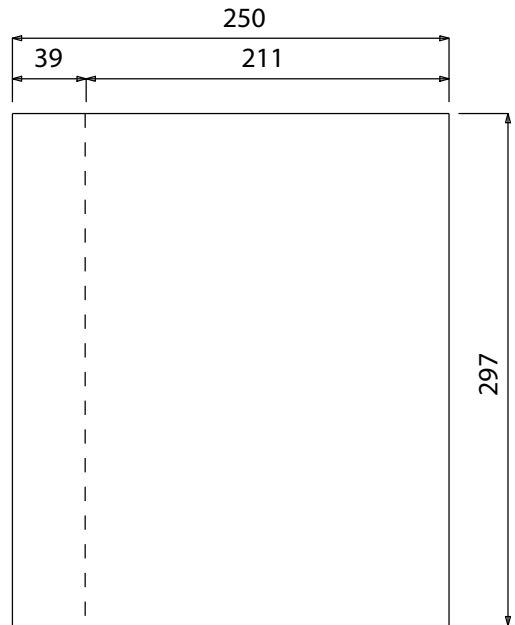

## A4 File Box 40mm

POD-A4W40

### Description

40mm capacity. Display pocket to front and spine

### Size

309 (L) x 240 (W) x 40 (D) mm

### Material

800mic Ice PP



### Product Design

D4350

## INSERT SHEET

### Trimmed Size

250 x 297mm

### Number out

1 (A3)

## PACKAGING DETAILS

### Outer Case Design No.

D6712

### Internal Dimensions (L x W x D)

643 (L) x 64 (W) x 473 (D) mm

### Style

0201 GLUED

### External Dimensions

659 (L) x 80 (W) x 489 (D) mm

### Material

150KT BC FLUTE

### Case Weight

9.5 Kg

### Unit QTY Per Box

50

## LABEL



A4 File Box 40mm

POD-A4W40

QTY

50

9.5Kg

MADE IN EU

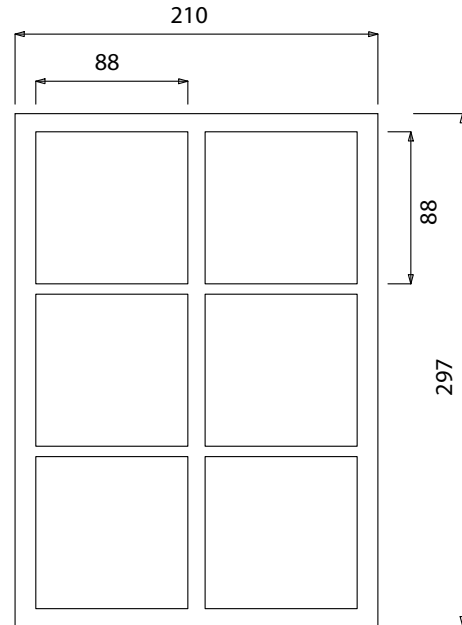

## Magazine File

POD-MF4C

Description	Flat pack storage file	
Size	104 (W) x 325 (H) x 257 (D) mm	
Material	Frosted PP	
Product Design	D5684	

## INSERT SHEET

Trimmed Size	88 x 88 mm
Number out	6 (A4)

## PACKAGING DETAILS

Outer Case Design No. D****	Internal Dimensions (L x W x D) 405 (L) X 335 (W) X 365 (D) mm
Style 0201 GLUED	External Dimensions 405 (L) X 335 (W) X 365 (D) mm
Material 150KT BC FLUTE	Case Weight 11.2 Kg
Unit QTY Per Box 20	

## LABEL



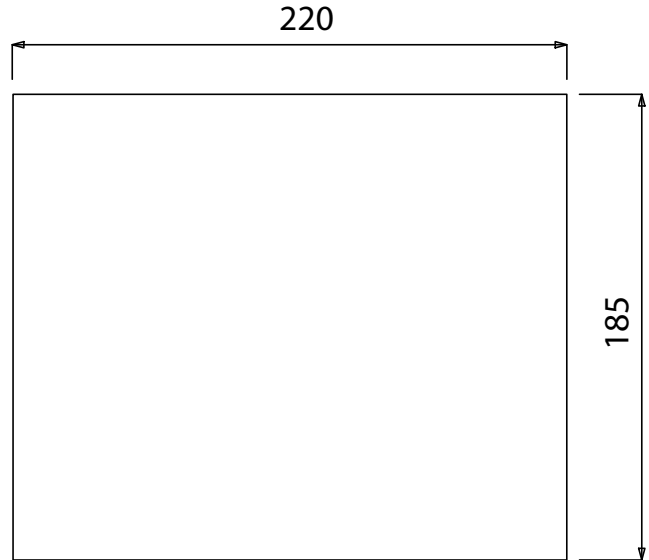

## Mouse Mat

POD-MM

### Description

High tracking surface. Non slip backing.

### Size

230 (L) x 195 (W) x 2 (D) mm

### Material

415mic Mark Resist PVC



### Product Design

D5688

## INSERT SHEET

### Trimmed Size

220 x 185mm

### Number out

1 (A4)

## PACKAGING DETAILS

### Outer Case Design No.

D6714

### Style

0201 GLUED

### Material

150KT BC FLUTE

### Unit QTY Per Box

50

### Internal Dimensions (L x W x D)

235 (L) x 200 (W) x 90 (D) mm

### External Dimensions

251 (L) x 216 (W) x 122 (D) mm

### Case Weight

2.7 Kg

## LABEL



Mouse Mat

POD-MM

QTY

50

2.7Kg

MADE IN EU

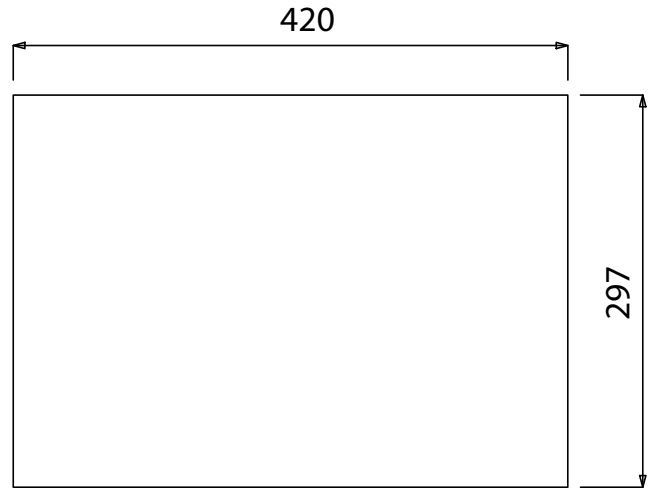

## A3 Mat POD-MM3

Description	<b>Durable surface. Non slip backing.</b>
Size	<b>435 (L) x 315 (W) x 2 (D) mm</b>
Material	<b>415mic Mark Resist PVC</b> 
Product Design	<b>D5691</b>

## INSERT SHEET

Trimmed Size	<b>420 x 297 mm</b>
Number out	<b>1 (A3)</b>

## PACKAGING DETAILS

Outer Case Design No. <b>D6715</b>	Internal Dimensions (L x W x D) <b>442 (L) x 322 (W) x 126 (D) mm</b>
Style <b>0201 GLUED</b>	External Dimensions <b>458 (L) x 338 (W) x 158 (D) mm</b>
Material <b>150KT BC FLUTE</b>	Case Weight <b>14.5 Kg</b>
Unit QTY Per Box <b>75</b>	

## LABEL

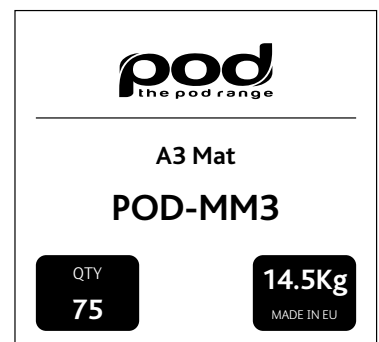

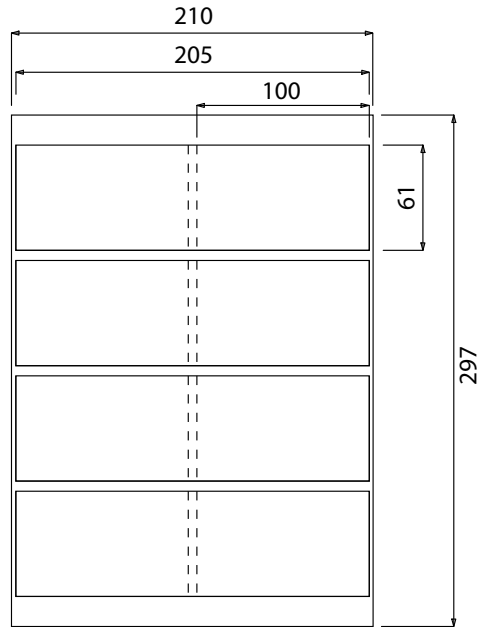
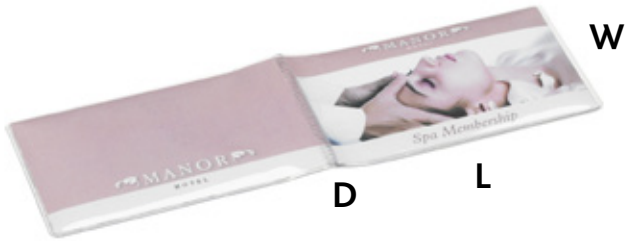

## Travel Card Wallet

POD-OCW

Description	<b>Durable clear card wallet</b>
Size	<b>103 (L) x 72 (W) x 4 (D) mm</b>
Material	<b>400mic Clear PVC</b> 
Product Design	<b>D5328</b>

## INSERT SHEET

Trimmed Size	<b>205 x 61mm</b>
Number out	<b>4 (A4)</b>

## PACKAGING DETAILS

Outer Case Design No. <b>D6716</b>	Internal Dimensions (L x W x D) <b>215 (L) x 140 (W) x 58 (D) mm</b>
Style <b>0201 GLUED</b>	External Dimensions <b>231 (L) x 156 (W) x 90 (D) mm</b>
Material <b>150KT BC FLUTE</b>	Case Weight <b>1 Kg</b>
Unit QTY Per Box <b>100</b>	

## LABEL



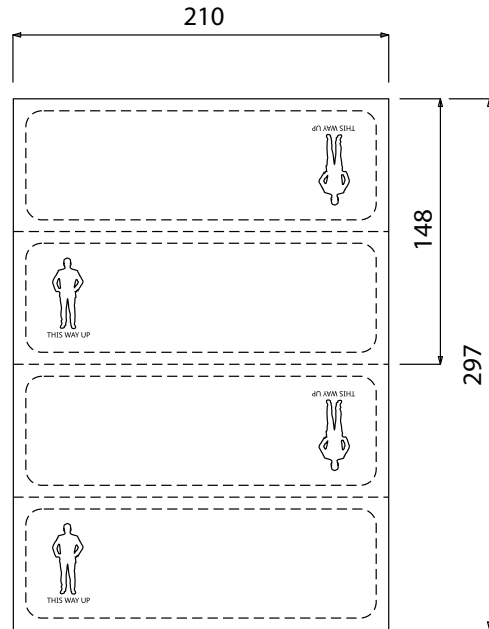

## Name Plate Display

POD-NP210

Description	<b>Double sided name plate tent card</b>
Size	<b>213 (L) x 78 (D) x 78 (H) mm</b>
Material	<b>800mic Ice PP</b> 
Product Design	<b>D5577</b>

## INSERT SHEET

Trimmed Size	<b>210 x 148 mm</b>
Number out	<b>2 (A4)</b>

## PACKAGING DETAILS

Outer Case Design No.	<b>D6719</b>	Internal Dimensions (L x W x D)	<b>363 (L) x 217 (W) x 90 (D) mm</b>
Style	<b>0201 GLUED</b>	External Dimensions	<b>379 (L) x 233 (W) x 122 (D) mm</b>
Material	<b>150KT BC FLUTE</b>	Case Weight	<b>2.4 Kg</b>
Unit QTY Per Box	<b>50</b>		

## LABEL

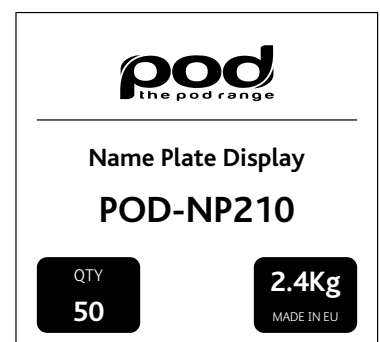

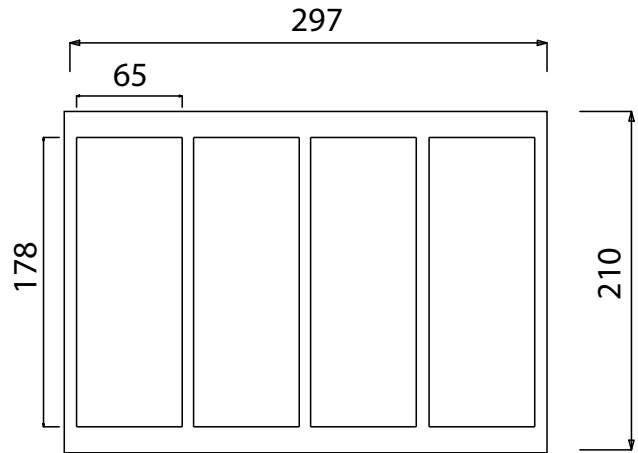

## A5 Leaflet Dispenser

POD-PLDA5

Description	<b>Flat pack leaflet dispenser</b>
Size	<b>221 (H) x 178 (W) x 36 (D) mm</b>
Material	<b>1200mic Frosted PP</b> 
Product Design	<b>D4500</b>

## INSERT SHEET

Trimmed Size	<b>178 x 65mm</b>
Number out	<b>4 (A4)</b>

## PACKAGING DETAILS

Outer Case Design No. <b>D6720</b>	Internal Dimensions (L x W x D) <b>333 (L) x 185 (W) x 150 (D) mm</b>
Style <b>0201 GLUED</b>	External Dimensions <b>349 (L) x 101 (W) x 182 (D) mm</b>
Material <b>150KT BC FLUTE</b>	Case Weight <b>3.8 Kg</b>
Unit QTY Per Box <b>50</b>	

## LABEL



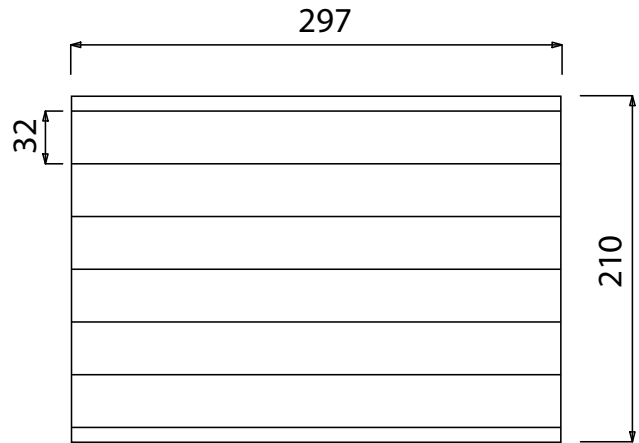

## 30cm Ruler

POD-30R

### Description

Clear ruler with increments in millimetres and inches

### Size

318 (L) x 53 (W) x 5 (D) mm

### Material

Crystal Polystyrene



### Product Design

D5690

## INSERT SHEET

### Trimmed Size

32 x 297mm

### Number out

6 (A4)

## PACKAGING DETAILS

### Outer Case Design No.

D6717

### Internal Dimensions (L x W x D)

325 (L) x 325 (W) x 133 (D) mm

### Style

0201 GLUED

### External Dimensions

341 (L) x 341 (W) x 165 (D) mm

### Material

150KT BC FLUTE

### Case Weight

7 Kg

### Unit QTY Per Box

100

## LABEL



30cm Ruler

POD-30R

QTY  
100

7Kg  
MADE IN EU



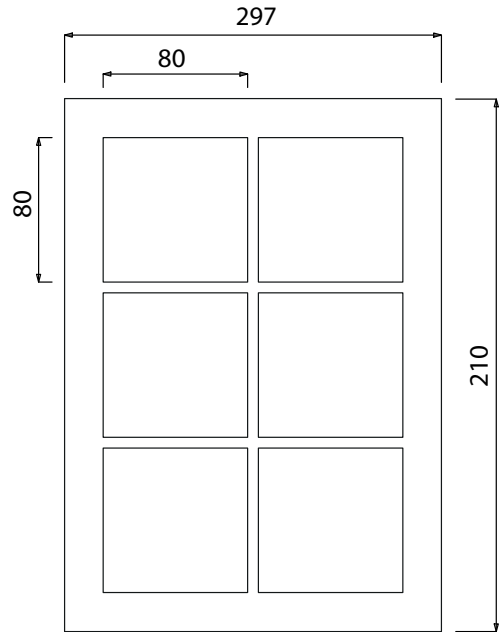

## Square Coaster

POD-SQC

### Description

Square coaster with a crystal clear finish

### Size

95 (L) x 95 (W) x 5 (D) mm

### Material

Crystal Polystyrene



### Product Design

D5689

## INSERT SHEET

### Trimmed Size

80 x 80mm

### Number out

6 (A4)

## PACKAGING DETAILS

### Outer Case Design No.

D6718

### Internal Dimensions (L x W x D)

305 (L) x 237 (W) x 225 (D) mm

### Style

0201 GLUED

### External Dimensions

321 (L) x 253 (W) x 257 (D) mm

### Material

150KT BC FLUTE

### Case Weight

7 Kg

### Unit QTY Per Box

200

## LABEL



Square Coaster

POD-SQC

QTY

200

7Kg

MADE IN EU

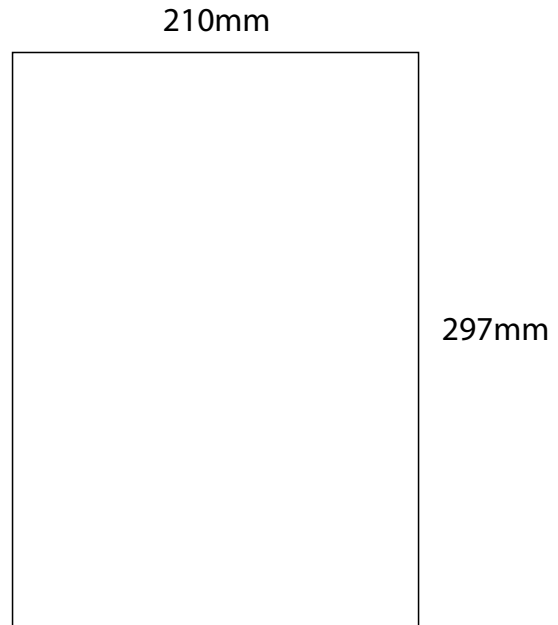

## A4 Display Unit

POD-TA4

Description	Double sided display unit
Size	190 (W) x 299 (H) x 85 (D) mm
Material	800mic Gloss PP 
Product Design	D5171

## INSERT SHEET

(2 are required for a double sided display)

Trimmed Size	297 x 210mm
Number out	1 (A4)

## PACKAGING DETAILS

Outer Case Design No. <b>D6130</b>	Internal Dimensions (L x W x D) <b>305 (L) x 220 (W) x 420 (D) mm</b>
Style <b>0201 GLUED</b>	External Dimensions <b>321 (L) x 236 (W) x 452 (D) mm</b>
Material <b>150KT BC FLUTE</b>	Case Weight <b>3.3 Kg</b>
Unit QTY Per Box <b>20</b>	

## LABEL

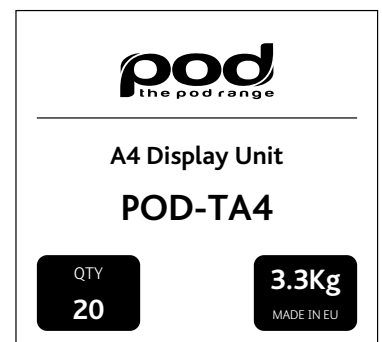

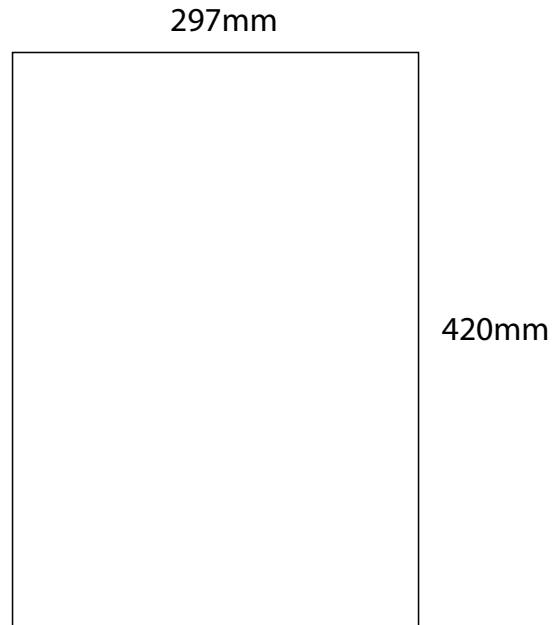

## A3 Display Unit

POD-TA3

Description	Double sided display unit	
Size	282 (W) x 427 (H) x 118 (D) mm	
Material	500mic Gloss PP	
Product Design	D6456	

## INSERT SHEET

(2 are required for a double sided display)

Trimmed Size	420 x 297mm
Number out	1 (A3)

## PACKAGING DETAILS

Outer Case Design No.	D6600	Internal Dimensions (L x W x D)	430 (L) x 306 (W) x 330 (D) mm
Style	0201 GLUED	External Dimensions	446 (L) x 322 (W) x 352 (D) mm
Material	150KT BC FLUTE	Case Weight	3.4 Kg
Unit QTY Per Box	10		

## LABEL



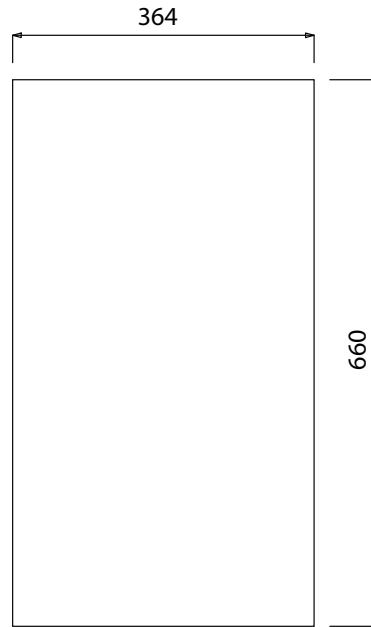

## Totem 660mm

POD-T660

Description	Double sided display unit
Size	360 (W) x 668 (H) x 130 (D) mm
Material	500mic Clear PET 
Product Design	D6458

## INSERT SHEET

(2 are required for a double sided display)

Trimmed Size	660 x 364mm
Number out	1

## PACKAGING DETAILS

Outer Case Design No. <b>D6474</b>	Internal Dimensions (L x W x D) <b>665 (L) x 366 (W) x 45 (D) mm</b>
Style <b>0201 GLUED</b>	External Dimensions <b>675 (L) x 378 (W) x 60 (D) mm</b>
Material <b>150KT BC FLUTE</b>	Case Weight <b>1 Kg</b>
Unit QTY Per Box <b>1</b>	

## LABEL



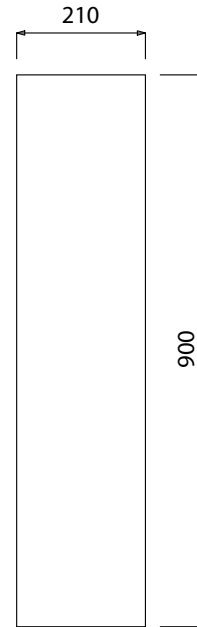

## Totem 900mm

POD-T900

Description	Double sided display unit
Size	387 (W) x 925 (H) x 287 (D) mm
Material	500mic Clear PET 
Product Design	D6507

## INSERT SHEET

(2 are required for a double sided display)

Trimmed Size	900 x 210mm
Number out	1

## PACKAGING DETAILS

Outer Case Design No. <b>D6554</b>	Internal Dimensions (L x W x D) <b>909 (L) x 290 (W) x 60 (D) mm</b>
Style <b>0201 GLUED</b>	External Dimensions <b>923 (L) x 303 (W) x 65 (D) mm</b>
Material <b>150KT BC FLUTE</b>	Case Weight <b>1.2 Kg</b>
Unit QTY Per Box <b>1</b>	

## LABEL



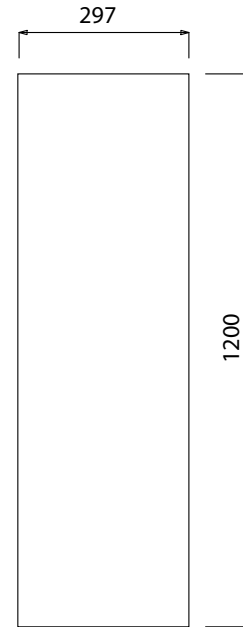

## Totem 1200mm

POD-T1200

Description	Double sided display unit
Size	512 (W) x 1213 (H) x 348 (D) mm
Material	800mic Clear PET 
Product Design	D6498

## INSERT SHEET

(2 are required for a double sided display)

Trimmed Size	1200 x 297mm
Number out	1

## PACKAGING DETAILS

Outer Case Design No.	D6548	Internal Dimensions (L x W x D)	1220 (L) x 352 (W) x 50 (D) mm
Style	0201 GLUED	External Dimensions	1235 (L) x 365 (W) x 55 (D) mm
Material	150KT BC FLUTE	Case Weight	1.8 Kg
Unit QTY Per Box	1		

## LABEL



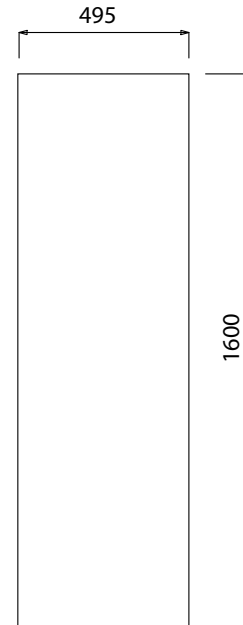

## Totem 1600mm POD-T1600

Description	Double sided display unit
Size	716 (W) x 1613 (H) x 444 (D) mm
Material	800mic Clear PET 
Product Design	D6500

### INSERT SHEET

(2 are required for a double sided display)

Trimmed Size	1600 x 495mm
Number out	1

### PACKAGING DETAILS

Outer Case Design No. <b>D6465</b>	Internal Dimensions (L x W x D) <b>1615 (L) x 527 (W) x 109 (D) mm</b>
Style <b>0201 GLUED</b>	External Dimensions <b>1630 (L) x 540 (W) x 125 (D) mm</b>
Material <b>150KT BC FLUTE</b>	Case Weight <b>7.5 Kg</b>
Unit QTY Per Box <b>1</b>	

### LABEL



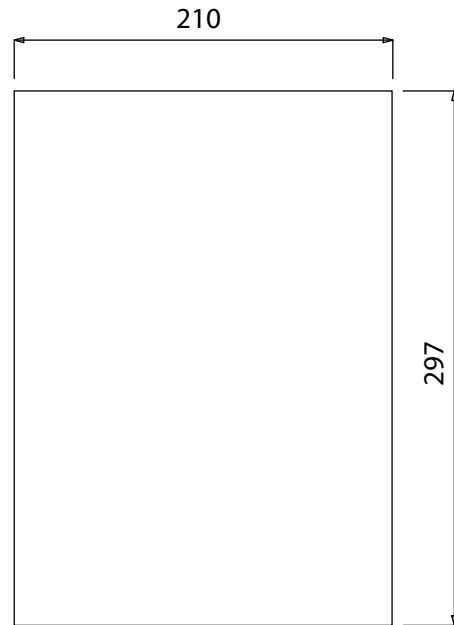
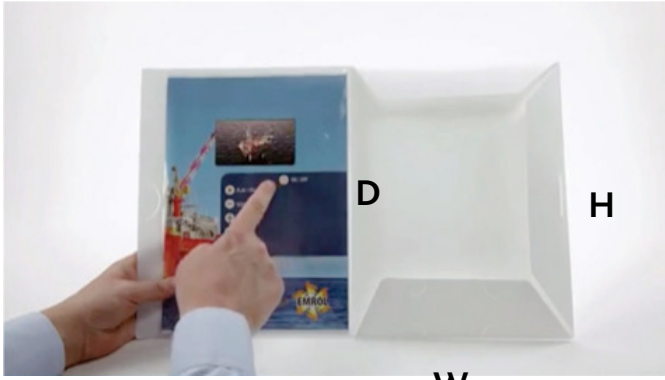

## Movie Presentation Folder

POD-MPF

Description	<b>Folder with built-in movie screen, speaker and controls</b>	
Size	309 (L) x 240 (W) x 3 (D) mm	
Material	500mic Ice PP	
Product Design	D6563	

## INSERT SHEET

Trimmed Size	210 x 297mm
Number out	1 (A4)

## PACKAGING DETAILS

Outer Case Design No.	D6605	Internal Dimensions (L x W x D)	225 (L) x 320 (W) x 23 (D) mm
Style	0201 GLUED	External Dimensions	325 (L) x 325 (W) x 30 (D) mm
Material	150KT BC FLUTE	Case Weight	0.5 Kg
Unit QTY Per Box	1		

## LABEL





Items included in the sample set:

POD-BBW	Bottle Gift Bag
POD-BBL	Large Boutique Bag
POD-BBS	Small Boutique Bag
POD-BBXS	X Small Boutique Bag
POD-XF4W	X File Binder
POD-2D40A4	A4 2 Ring Binder 40mm
POD-A4TFPB	Tuff A4 Binder
POD-A4B25	A4 4 Ring Binder 25mm
POD-A4B11	A4 4 Ring Binder 11mm
POD-A5B35	A5 2 Ring Binder 35mm
POD-A4WO	A4 Flat Folder
POD-A4W20	A4 File Box 20mm
POD-A4FOW	A4 Landscape Folder
POD-A4W40	A4 File Box 40mm
POD-MF4C	Magazine File
POD-A4BC	A4 Binding Cover
POD-MM	Mouse Mat
POD-MM3	A3 Mat
POD-OCW	Travel Card Wallet
POD-PLDA5	A5 Leaflet Holder
POD-30R	30cm Ruler
POD-SQC	Square Coaster
POD-NP210	Name Plate Display
POD-TA4	A4 Display Unit

**Sample Set**

POD-SS

Description	<b>Set of POD products with printed inserts</b>
Size	*
Material	*
Product Design	*

**INSERT SHEET**

Trimmed Size	*
Number out	*

**PACKAGING DETAILS**

Outer Case Design No. <b>D6724</b>	Internal Dimensions (L x W x D) <b>590 (L) x 500 (W) x 120 (D) mm</b>
Style <b>0201 GLUED</b>	External Dimensions <b>596 (L) x 506 (W) x 132 (D) mm</b>
Material <b>150KT BC FLUTE</b>	Case Weight <b>4.6 Kg</b>
Unit QTY Per Box <b>1</b>	

**LABEL**

	
<b>Sample Set</b>	
<b>POD-SS</b>	
<b>QTY</b> <b>1</b>	<b>4.6Kg</b> MADE IN EU



## Items included in the sample set:

POD-BBW	Bottle Gift Bag
POD-BBL	Large Boutique Bag
POD-BBS	Small Boutique Bag
POD-BBXS	X Small Boutique Bag
POD-XF4W	X File Binder
POD-2D40A4	A4 2 Ring Binder 40mm
POD-A4TFPB	Tuff A4 Binder
POD-A4B25	A4 4 Ring Binder 25mm
POD-A4B11	A4 4 Ring Binder 11mm
POD-A5B35	A5 2 Ring Binder 35mm
POD-A4WO	A4 Flat Folder
POD-A4W20	A4 File Box 20mm
POD-A4FOW	A4 Landscape Folder
POD-A4W40	A4 File Box 40mm
POD-MF4C	Magazine File
POD-A4BC	A4 Binding Cover
POD-MM	Mouse Mat
POD-MM3	A3 Mat
POD-OCW	Travel Card Wallet
POD-PLDA5	A5 Leaflet Holder
POD-30R	30cm Ruler
POD-SQC	Square Coaster
POD-NP210	Name Plate Display
POD-TA4	A4 Display Unit

## Sample Set & Display

POD-SSD

Description	<b>FSDU and set of POD samples with printed inserts</b>
Size	<b>460 (W) x 1500 (H) x 330 (D) mm</b>
Material	*
Product Design	*

## INSERT SHEET

Trimmed Size	*
Number out	*

## PACKAGING DETAILS

Outer Case Design No. <b>D6330</b>	Internal Dimensions (L x W x D) <b>1500 (L) x 523 (W) x 150 (D) mm</b>
Style <b>0201 GLUED</b>	External Dimensions <b>1542 (L) x 555 (W) x 158 (D) mm</b>
Material <b>150KT BC FLUTE</b>	Case Weight <b>8.8 Kg</b>
Unit QTY Per Box <b>1</b>	

## LABEL

